

Bei Stahlmantel  
ersetzt ein Formstück  
die Deckenplatten.

Bohrungen  
bauseits

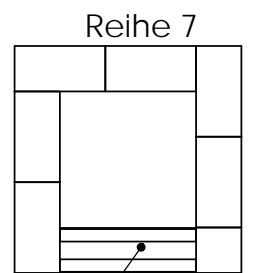
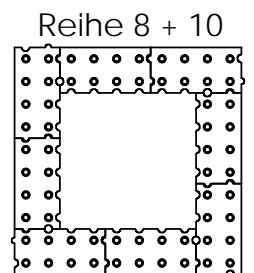
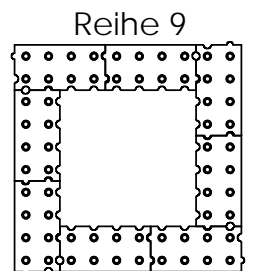
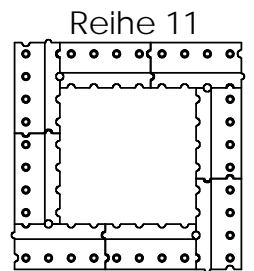
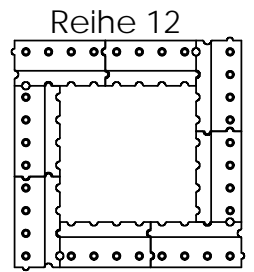
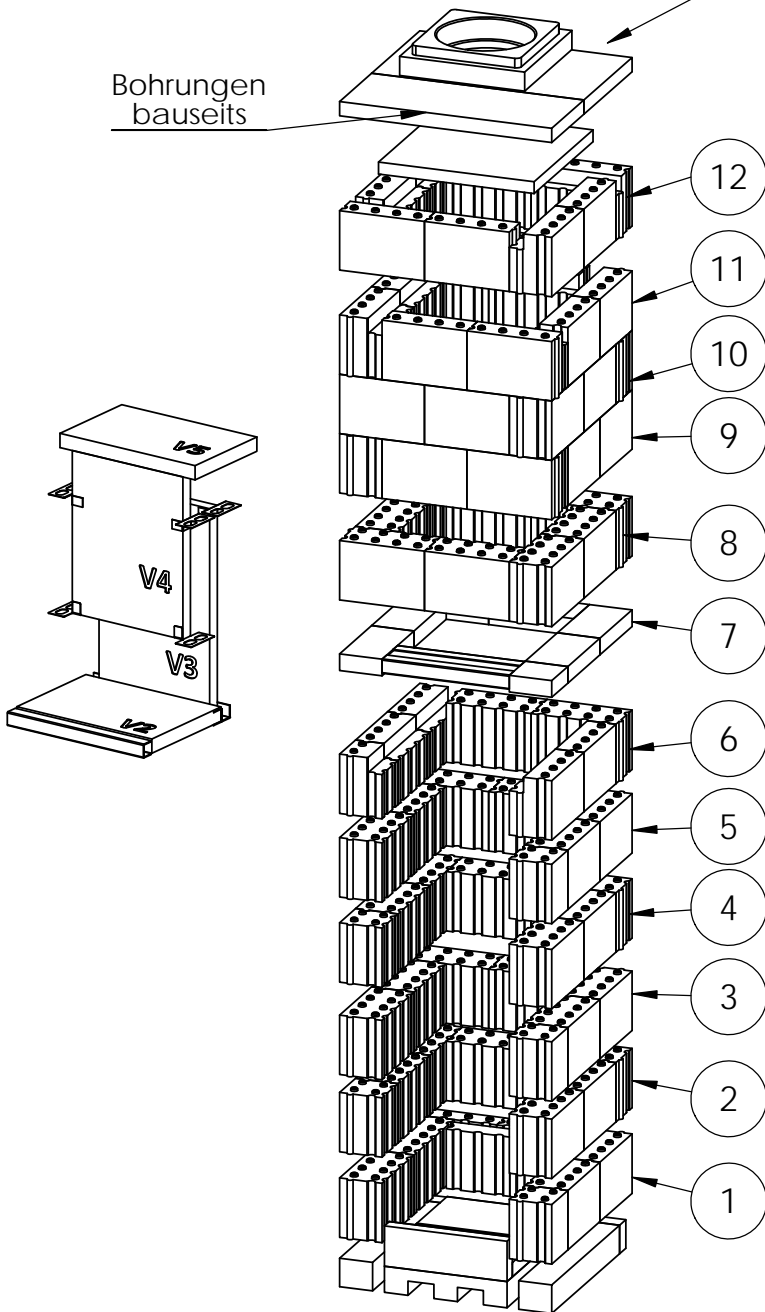

Auflageblech

Steine lose  
einstellen, damit  
Sekundärluft  
einströmen  
kann.

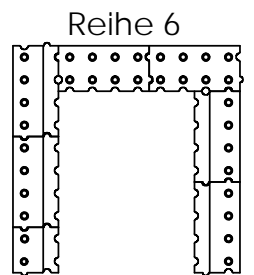
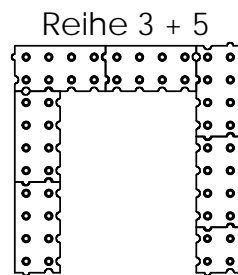
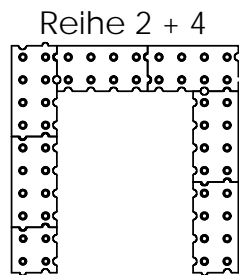
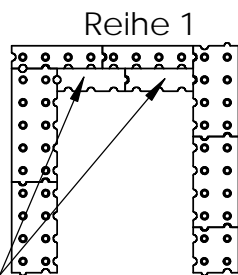

OFEN Innovativ GmbH  
Rotenbachweg 6  
86633 Neuburg / Rödendorf  
Tel. 08431-537007 Fax 537008

ZEICHNUNG NICHT SKALIEREN

ÄNDERUNG

BENENNUNG:  
Feuerraum SHK D5

ZEICHNUNGSPfad:  
D:\Dokumente\OneDrive\Dokumente\0\_Kandern\OfenInno\Palego 2\Aufbau\small

A4

GEZEICHNET  
GEPRÜFT

NAME  
Amrehn G.      DATUM  
07.01.2022

GEWICHT: 334.10

MASSSTAB: 1:15

BLATT 1 VON 2

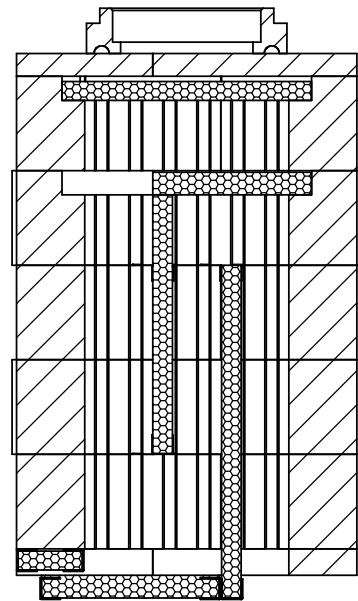
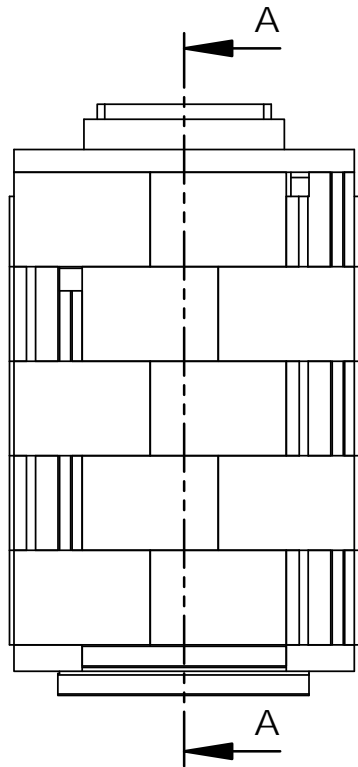

A-A (1 : 10)

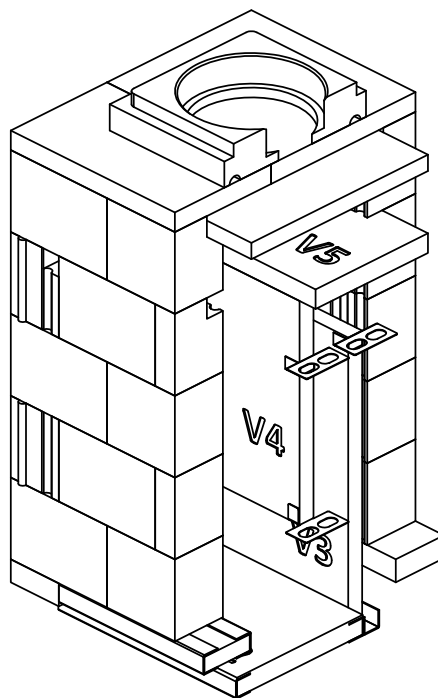

OFEN Innovativ GmbH  
 Rotenbachweg 6  
 86633 Neuburg / Rödenhof  
 Tel. 08431-537007 Fax 537008

ZEICHNUNG NICHT SKALIEREN

ÄNDERUNG

BENENNUNG:

SK D5

ZEICHNUNGSPfad:

D:\Dokumente\OneDrive\Dokumente\0\_Kandern\OfenInno\Palego 2\Aufbausmall

A4

GEZEICHNET	NAME Amrehn G.	DATUM 07.01.2022
------------	-------------------	---------------------

GEPRÜFT		
---------	--	--

GEWICHT:

MASSSTAB:1:15

BLATT 2 VON 2